

**PRODUCT SPECIFICATION - BULK ROLL HYDROGEL**

PROPERTY / TEST METHOD	SPECIFICATION
Volume Resistivity	1000 ohm-cm max
Stainless Steel (Skin Side) Adhesion (180° Peel)	300 g/in (118 g/cm) min <sup>1</sup>
Top Liner (Tie Side) Adhesion to Gel (90° Peel)	90 g/in (35 g/cm) max
Bottom Liner (Skin Side) Adhesion to Gel (90° Peel)	120 g/in (47 g/cm) max
Hydrogel Thickness	50 +/- 5 mils (1.3 +/- 0.1 mm)
Hydrogel pH	4.0 (+/- 1.0)
Roll Dimensions	Width - 8.75" (22 cm) Usable Gel, Length - 250' (76 m) +/-2%
Top Release Liner	2 mil (0.05 mm) LDPE
Bottom Release Liner	5 mil (0.13 mm) PET
Cytotoxicity Test (ISO 10933-5)	Non-Cytotoxic
Irritation Test (ISO 10933-10)	Non-Irritating
Sensitization Test (ISO 10933-10)	Non-Sensitizing
Shelf Life	Slit - 6 months <sup>2</sup> , Non-slit - 12 Months <sup>2</sup>
Core Size	Slit - 3" (8 cm), Non-slit - 6" (15 cm)

**TYPICAL PROPERTIES - BULK ROLL HYDROGEL**

PROPERTY / TEST METHOD	TYPICAL PROPERTIES
Volume Resistivity	550 ohm-cm
Stainless Steel (Skin Side) Adhesion (180° Peel)	400 g/in (157 g/cm) <sup>1</sup>
Top Liner (Tie Side) Adhesion to Gel (90° Peel)	9 g/in (4 g/cm)
Bottom Liner (Skin Side) Adhesion to Gel (90° Peel)	45 g/in (18 g/cm)
Hydrogel Thickness	50 mils (1.3 mm)
Hydrogel pH	3.5
Water Activity (a <sub>w</sub> )	0.66

<sup>1</sup> Stainless Steel is not a true measure of skin adhesion. AG2550 has good "quick grab" and excellent restick.

<sup>2</sup> Shelf life is for roll goods prior to conversion. Shelf life for finished goods is the responsibility of the converter.

Note: Converter assumes responsibility for material compatibility. However, should assistance be required, our professional chemical and engineering staff is available to support your technical needs.

**STORAGE CONDITIONS**

Short-Term Temperature (Less than One Month)	32°F - 104°F (0°C - 40°C)
Long-Term and Optimal Temperature	41°F - 80°F (5°C - 27°C)

**PACKAGING INFORMATION**

Box Size	17" x 17" x 12" (43 cm x 43 cm x 30 cm)
Box Weight	Approx. 80 lbs. (36 kg)
Pallet Size	Approx. 45" x 45" x 54" (114 cm x 114 cm x 137 cm)
Pallet Weight (16 Boxes per Pallet)	Approx. 1,310 lbs. (594 kg)

Additional storage and packaging information on following page.

**TOLL FREE:** +1 (866) 811-7257 • **FAX:** +1 (760) 728-3429 • **INTERNATIONAL:** +1 (760) 451-8000  
**E-MAIL:** info@axelgaard.com • **HEADQUARTERS:** Fallbrook, CA 92028, USA • **www.axelgaard.com**

**RECOMMENDED STORAGE CONDITIONS FOR BULK ROLL HYDROGELS**

Bulk roll hydrogels should be stored at ambient temperature at specific ranges noted below in Number 3. a. and b. Storage conditions outside these ranges can adversely affect product stability and product performance.

**THE FOLLOWING POINTS SHOULD BE FOLLOWED TO ENSURE ANTICIPATED PRODUCT PERFORMANCE:**

1. Keep hydrogel out of direct sunlight
2. Store in the original packaging
3. Maintain ambient storage conditions through product expiration
  - a. Short-Term (less than one month) Temperature: 32°F – 104°F (0°C – 40°C)
  - b. Long-Term and Optimal Temperature: 41°F – 80°F (5°C – 27°C)
4. To prevent dry out of hydrogel, liners should be kept on at all times until the gel is used or converted.

**SHELF LIFE**

The shelf life of the bulk roll hydrogels is guaranteed only through the shelf life of the unconverted hydrogel. Axelgaard Manufacturing Co., Ltd. has stipulated a 12-month shelf life from the date of manufacture for all non-slit bulk roll hydrogels and a 6-month shelf life from the date of manufacture for all slit bulk roll hydrogels.

**NOTE:** Axelgaard Manufacturing Co., Ltd. recommends compatibility testing of materials in contact with the hydrogel as certain materials may cause incompatibility problems when applied to the hydrogel.

**PACKAGING SPECIFICATION**

**MASTER ROLL DETAIL**

**BULK ROLL PACKAGING**

**SLIT GEL ROLL PACKAGING**

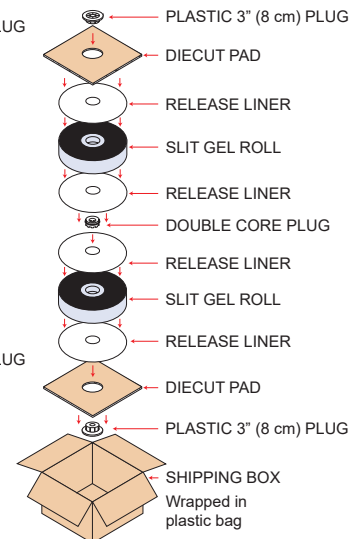
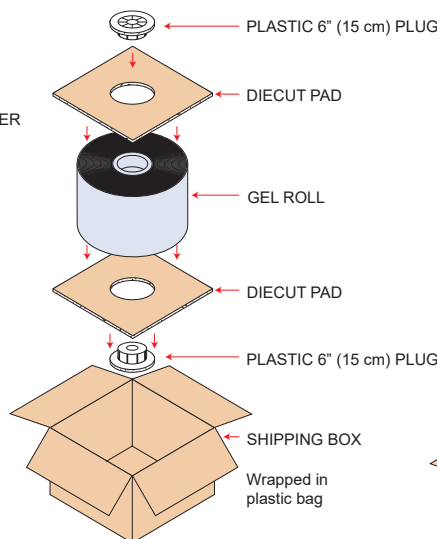
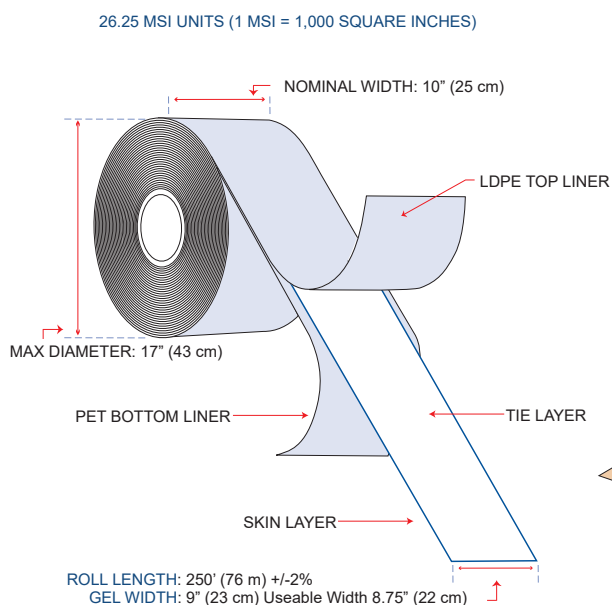

TOLL FREE: +1 (866) 811-7257 • FAX: +1 (760) 728-3429 • INTERNATIONAL: +1 (760) 451-8000  
E-MAIL: info@axelgaard.com • HEADQUARTERS: Fallbrook, CA 92028, USA • www.axelgaard.com